







**Information about the product**

Dimensions	528 x 423 cm
Safety zone	878 x 723 cm
Safety zone area	42 m <sup>2</sup>
Overall height	482 cm
Free fall height	184 cm
Amount of users	16
Product complies with EN 1176-1:2017-12	Yes
Availability of spare parts	Yes
Age range	3-12

According to EN 1176-1:2017-12 norm, the product requires applying a safety surface according to the product's free fall height.

**Functions**

-  Climbing
-  Balancing
-  Socializing
-  Sliding

**GRADIENT TECHNOLOGY**

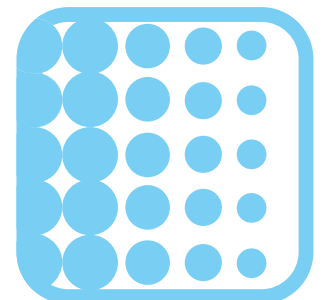

A painting technique that allows combining two colors, which smoothly blend into each other. It enables achieving a natural colour fusion effect.

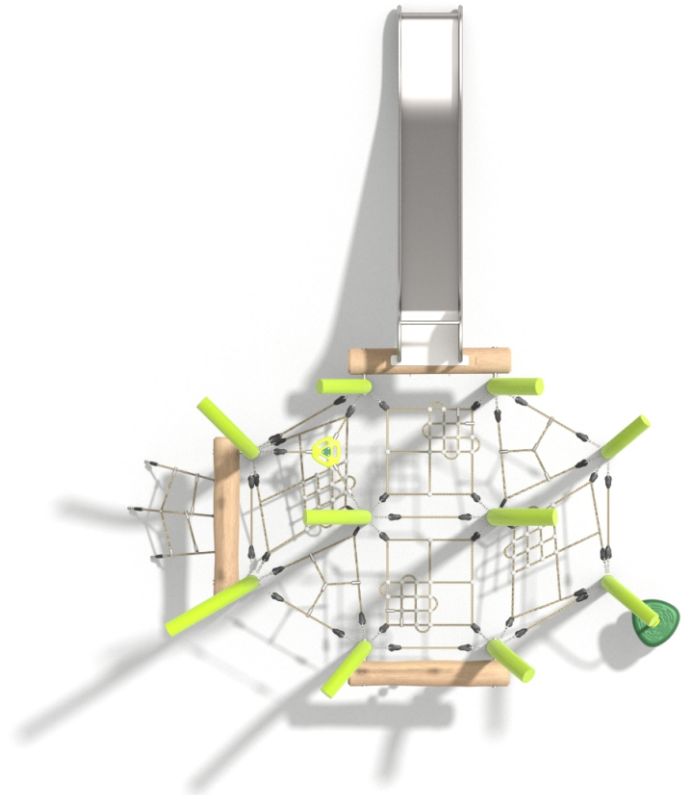
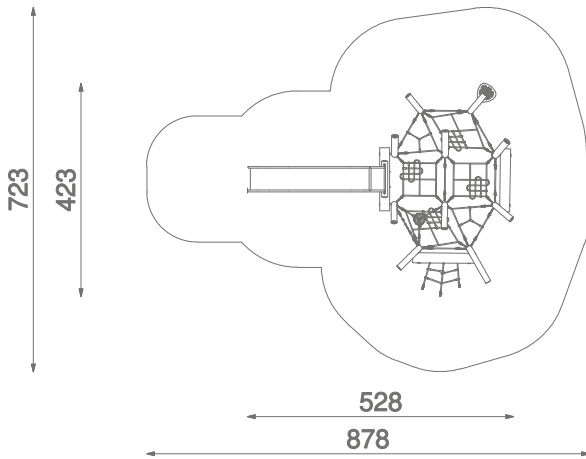
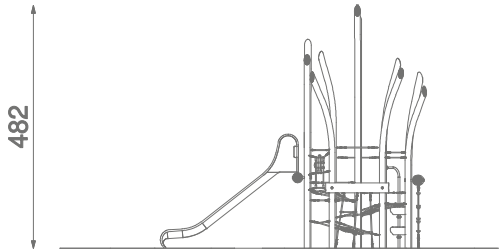

1:150

**Materiały**



Natural robinia wood



Steel construction: pipes, powder galvanized and covered in powder coating paint



Polypropylene ropes pp - multisplit type with a steel core and a diameter of 16 mm

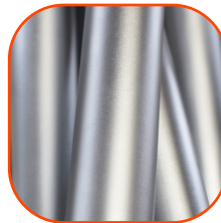

Elements construction made of stainless steel AISI 304